







KS-F KÜBERIT STAIR-NOSING PROFILES

We offer a large selection of decorative stair-nosings for new or retrofit installations. Proper application of stair-nosing protects the floor covering in place and provides safety protection by increasing visibility and slip resistance.

Heavy duty and sloped edged, this retrofit safety stair step edge protection is suitable for all types of floor coverings. Slip-resistant PVC inserts are available in many colors and this ridged surface stair-nosing is countersunk drilled and can be installed with either screws or an appropriate adhesive.

Retrofit stair step edge protection for:

-  Resilient
-  Ceramic
-  Laminate
-  Natural Stone
-  Wood
-  Carpet

	Product Code	Material Finish and Profile Options			Length: 2.50m = 8' 2-1/2"				Visible Surface			
		A1	A2	A3	H = mm - in.		W = mm - in.		V1 = mm - in.		V2 = mm - in.	
1	KS-F-300-	C	—	—	28mm	1-3/32"	60mm	2-3/8"	28mm	1-3/32"	60mm	2-3/8"
2	KS-F-500-	C	C	C	44mm	1-3/4"	54mm	2-1/8"	44mm	1-3/4"	54mm	2-1/8"

C = Countersunk Drilled Suggested screws: Phillips No. 6, length 1-3/16" **PVC insert must be ordered separately.**
All conversions are nominal. Conversions from mm to inch are to the closest approximate fractional measurement.

STEP UP THE SOPHISTICATION ..WITH KÜBERIT PROFILES.

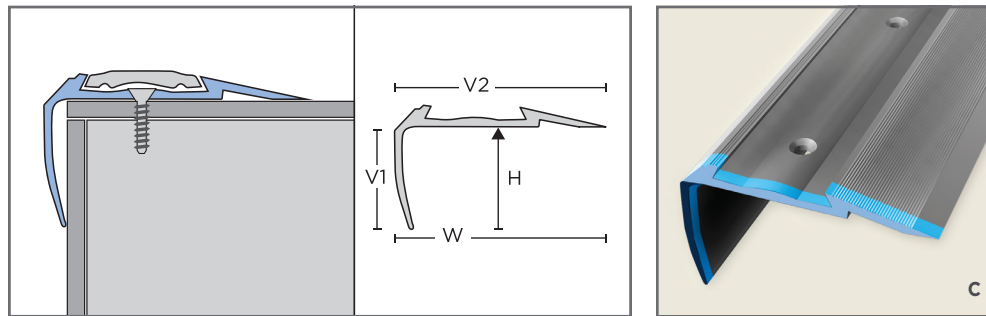

Product Material Codes

Anodized Aluminum



Retrofit stair step edge protection for all types of floor coverings:

- Heavy duty
- Sloped edge
- Slip-resistant PVC insert is available in many colors
- Installed using adhesive or screws
- Ridged surface



PVC Inserts for safety stair-nosings

- Inserts are exchangeable
- Use with appropriate adhesive
- Use at room temperature to facilitate insertion
- Ridged and Smooth versions are available in all nine color options

Customized Options

- Profiles are available in custom lengths, colors and finishes upon request.
- All customized options require a minimum quantity with longer lead times to be expected.
- Please see our catalog or website for more information on customized options.

This selection of Küberit Profiles is available in anodized aluminum. Please see our catalog or website for more information on customized options.

Aluminum Natural (AN*): Can be sensitive to alkaline substances and should be tested for suitability especially if chemical stresses are anticipated. Cementitious materials together with moisture can become alkaline and depending on the concentration and length of exposure can cause corrosion. Therefore it is very important to remove all excess setting material from all visible surfaces, ensure that the profile is securely embedded, and all gaps are filled to prevent the accumulation of alkaline water. Aluminum profiles can become oxidized over time, and while this oxidized layer can be removed with a conventional polishing solution, it will form again. Resistant to mold and fungi. (**Best suited for flooring applications.*)

Anodized Aluminum (A1, A2, A3, AP, AT): Anodization provides a layer that maintains the appearance during normal use. However, the surface of anodized profiles are prone to scratches and wear and may become damaged with the use of setting material. Therefore, it is very important to remove all excess setting material from all visible surfaces.

Anodized aluminum can be cleaned periodically with neutral cleaning solutions. Do not use abrasive cleaning materials. Resistant to mold and fungi.

Stainless Steel (SP, SB): Stainless steel profiles are roll-formed and therefore have a different contour than extruded aluminum. They can sustain high mechanical stresses and have a higher resistance to chemicals and acids. This quality makes them well suited for installation in the food or health industry as well as residential properties. Küberit stainless steel profiles are formed using stainless steel 1.4301 = V2A but even so, it cannot withstand all chemical exposures such as certain chlorine or chloride concentrations or hydrochloric and hydrofluoric acid.

Stainless steel should be cleaned periodically with a mild household cleanser. This will help maintain the appearance and reduce risk of corrosion. All cleaning materials should be free of hydrochloric acid, hydrofluoric acid, and chlorides. If treated with a chrome-polishing agent, stainless steel will develop a sheen over time.

Extruded Brass (X1): Our brass profiles are developed with prime choice raw material in order to guarantee tolerance and endurance to chemical and mechanical solicitations.

Brass profiles can be used for indoor and outdoor applications that require higher mechanical loads and/or highly frequented areas. Our standard version of brass polished may oxidize on exposed surfaces and the visible surface can change depending on environmental influences. Air humidity and aggressive cleaning agents accelerate oxidation. Brass generally acquires

a so-called natural patina over time, which can be removed by commercially available polishing agents. The brass surface must be wiped dry after cleaning. Cleaning agents that are not wiped off can leave stains. Surface oxidation will be repeated and can also occur during storage and transport.

NOTE: Limited availability for custom brass profile orders.

Wood Decor (W1-W7): Our natural looking wood decors are digitally printed paper foil with AC3 abrasion-resistant hot coating designed for light commercial and residential applications. The aluminum profile is wrapped with this high quality foil and obtains a natural look due to the wood grain patterning of the foil. The higher abrasion-resistant AC5 coating is designed for heavy commercial applications and is available upon request.

NOTE: If not offered in the catalog, wood decors are custom orders subject to minimum quantities and longer lead times.

CUTTING AND INSTALLATION

Be certain to always measure and dry fit the profiles before installation.

Aluminum profiles may be cut using various types of saws, including chop saws, miter saws, hacksaws or variable speed angle grinders set at the lowest speed.

Stainless steel profiles may be cut using variable speed angle grinders or band saws suitable for cutting stainless steel (metal cutting blades). Maintain the correct cutting speed to avoid the steel turning blue.

Always observe and follow all safety instructions from the cutting tool manufacturer and make certain to file off any burrs before final installation.

Installation with Adhesive - U

- Be certain to always measure and dry fit the profiles before installation.
- Ensure that the floor or wall is dry, even and free of debris. Under certain circumstances, it may be necessary to use a suitable primer before installation.
- Cut the profile to the required length using an appropriate blade and cutting tool.
- Glue the entire surface to the substrate with a suitable adhesive.
- The profile angle must always be filled flush with the surface and with a suitable adhesive.
- The inside profile height must be chosen so that the floor covering is flush with the surface.
- Height differences between profile and floor coverings must be avoided.
- Cut the profile exactly to the vertical profile angle.
- Set the flooring directly against the trim with or without a grout joint. Remember that tile flooring is installed with a small joint and resilient flooring without a joint.

- Remove any excess setting material with a suitable cleanser. Remove the protective film only after the joint material has been filled in.

Installation with Adhesive - P

- (Same as for U)
- Perforated trims are made to be embedded into the adhesive of the flooring without the use of screws, because they would not be flush with the profile.

Installation with Adhesive - B

- (Same as for U)
- These bendable profiles allow for a curved installation. It is recommended that they be bent on site to project specifications with the available Küberit Bending Machine.

Installation with Adhesive/Screws/Nails - C

- (Same as for U)
- Screws and/or nails may be used instead of glue, or in conjunction with adhesive.

Installation of PVC Inserts

- The PVC inserts must be at room temperature for a minimum of 24 hours before installation. It is recommended to install the inserts with evenly distributed dots of glue.
- Proper installation requires that the Inserts are not slid into the profile, but pressed together and inserted from the top of the profile.

Installation with Self-Stick - S

- Be certain to always measure and dry fit the profiles before installation.
- Ensure that the floor is dry, even and free of debris.
- Height differences between profile and floor coverings must be avoided
- Cut the profile to the required length using an appropriate blade and cutting tool.
- Remove the foil covering from the self-adhesive and adhere the profile to the floor.

Installation of Stainless Steel

- (Same as for U)
- Cut the profile to the required length using an appropriate blade and cutting tool for stainless steel.

Installation of Extruded Brass

- (Same as for C)
- Cut the profile to the required length using an appropriate blade and cutting tool for extruded brass.

For questions regarding maintenance or installation, please contact your Küberit customer service representative.

888-284-7567